

Technical Description

for

OFFICE CABIN and SANITARY CABIN

CONTENTS

1	General information	2
1.1	Dimensions (mm) and weights (kg):	2
1.2	Abbreviations	3
1.3	Standard configuration	3
1.4	Insulation	4
1.5	Load bearing capacity	4
1.6	Basic principles of the static calculations	5
1.7	Sound insulation	5
2	Container design	5
2.1	Floor	5
2.2	Roof	6
2.3	Corner posts	6
2.4	Wall panels	7
2.5	Partition walls	7
2.6	Doors	8
2.7	Windows	9
3	Electrical installation	9
3.1	Technical data	10
3.2	Heating and air conditioning	12
4	Miscellaneous	13
4.1	Transport height	13
4.2	Construction / Assembly / Statics / Servicing	13
4.3	Handling	14
4.4	Certification	14
4.5	Paint	14
5	Equipment options for sanitary cabins and fixtures in office cabins	14
5.1	WATER INSTALLATION	15

6	Appendix.....	16
6.1	Arrangement options for 10', 16' and 20', max. external height 2.8 m.....	16
6.2	Arrangement options for 10', 16' and 20', max. external height 2.96 m.....	17
6.3	Arrangement options for 24' and 30', max. external height 2.8 m	18
6.4	Arrangement options for 24' and 30', max. external height 2.96 m	19
6.5	Standard foundation plan for 10', 16' und 20' cabin	20
6.6	Standard foundation plan for 24' and 30' cabin.....	21
6.7	Handling instructions for 10', 16' and 20' Transpack cabins.....	22
6.8	Handling instruction for 30' Transpack cabins	23

1 General information

The following description relates to the finish/design and equipment of new office and sanitary cabins.

Our cabins match the ISO-norm dimensions and have therefore many advantages of that system. They consist of a robust frame construction and interchangeable wall panels.

The design of the CTX standard office cabin is marked with¹, the design of the standard sanitary unit with².

All design options not marked with ¹ or ² only will be delivered after these have been mentioned in the written agreement.

1.1 Dimensions (mm) and weights (kg):

Type	External			Internal			Weight (approx. specifications)		
	Length	Width	Height	Length	Width	Height	BM	BU	SU
10'	2,989	2,435	2,591 2,800 2,960	2,795	2,240	2,340 2,540 2,700	1,150 1,350	1,200 1,200	1,450 1,550
16'	4,885	2,435	2,591 2,800 2,960	4,690	2,240	2,340 2,540 2,700	1,600 1,750	1,550 1,600	
20'	6,055	2,435	2,591 2,800 2,960	5,860	2,240	2,340 2,540 2,700	1,950 2,000	1,750 1,800	2,450 2,550
24'	7,335	2,435	2,591 2,800 2,960	7,140	2,240	2,340 2,540 2,700	2,300 2,400	2,050 2,150	
30'	9,120	2,435	2,591 2,800 2,960	8,925	2,240	2,340 2,540 2,700	2,550 2,800	2,450 2,500	

* The mentioned dimensions and weights are valid for standard configuration (see 1.3.) and can vary depending on configuration and equipment.

1.2 Abbreviations

The following abbreviations are used in the document:

Office cabin with mineral wool insulation	BM
Office cabin with PU foam insulation	BU
Sanitary cabin with mineral wool insulation	SA
Sanitary cabin with PU foam insulation	SU
Mineral wool	MW
Polyurethane foam	PU
Internal height	RIH
External cabin height	CAH
Transpack (BM/BU in a package)	TP
Toughened safety glass	ESG

1.3 Standard configuration

Office cabin 10'

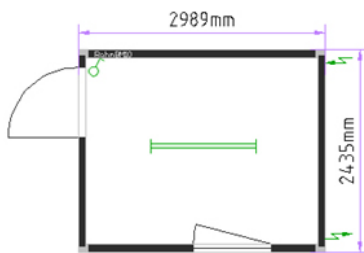

Office cabin 16'

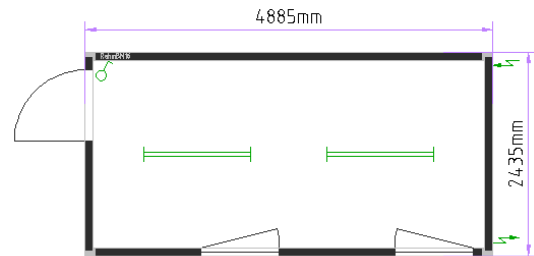

Office cabin 20'

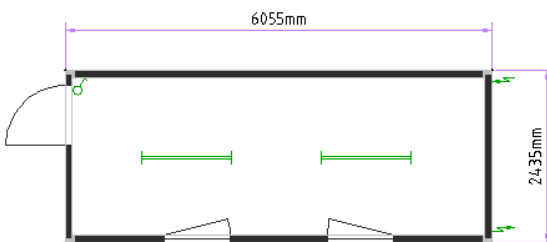

Office cabin 30'

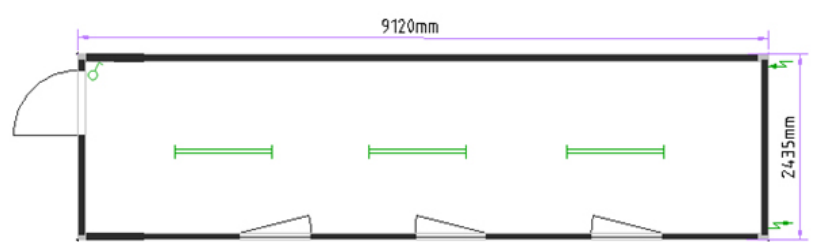

Sanitary cabin 10'

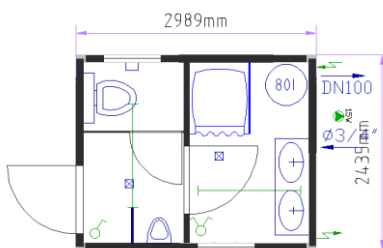

Sanitary cabin 20'

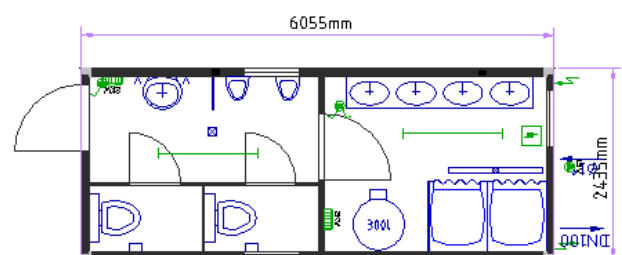

1.4 Insulation

Component	Insulation type	Thickness	U-value (W/m ² K)*
Roof			
	MW ^{1/2}	100	0.359
	MW	140	0.233
	PU	100	0.198
	PU	140	0.145
Wall element			
	MW ¹	60	0.574
	MW	100	0.348
	PU ²	60	0.380
	PU	110	0.210
Floor			
	MW ^{1/2}	60	0.548
	MW	100	0.364
	PU	100	0.196
Window			
	standard insulated window ^{1/2}	4/16/4 mm	2.90
	window insulation with gas filling	4/16/4 mm	1.10
External door			
	polystyrene	40 mm	1.4

* The U-values apply to the stated insulation thickness in the space between the timber frames in a half-timbered construction (within the panel).

Further insulation options upon request!

1.5 Load bearing capacity

floor load:

ground floor: max. load capacity 2.0 kN/m² (200 kg/m²)

top floors: max. load capacity 1.5 kN/m² (150 kg/m²)

snow load: max. load capacity 1.0 kN/m² (100 kg/m²)

(equates to a typical snow load on the ground of $s_{sk} 1.25$ kN/m² (125 kg/m²) according to EN1991-1-3 with the national application document B1991-1-3)

wind load: 90 km/h [25 m/s] - terrain category III

When wind speeds are higher than 90 km/h (25m/s) additional safety measures on the cabins need to be carried out (anchoring, screwing). Such measurements are to be calculated by approved specialists taking into consideration local standards and conditions.

All calculations were undertaken according to the European standards of ENV.

Higher load capacity upon request

1.6 Basic principles of the static calculations

exposed side	EN 1990 (Eurocode 0, basic principles)
	EN 1991-1-3 (Eurocode 1, snow)
	EN 1991-1-4 (Eurocode 1, wind)
non-exposed side	EN 1993-1-1 (Eurocode 3, steel)
	EN 1995-1-1 (Eurocode5, wood)

1.7 Sound insulation

33 - 44 dB

2 Container design

2.1 Floor

- frame construction:**
- made of cold rolled, welded steel profiles, thickness 2,5/3 mm
 - 4 corner casts, welded
 - two fork lift pockets on the long side (apart from type 30')
 - inside clearance of fork lift pockets: 352 x 85 mm
 - fork lift pocket distance in centre: 2,050 mm^{1/2},
optional: 950 mm, 1,650 mm or without fork lift pockets
 - steel cross members with omega profiles, thickness = 2.5 mm
 - optional: double amount of floor cross members
double amount of floor cross members with underpadding

insulation:

insulation type: **MW**^{1/2}
fire behaviour A1 (non-flammable) according to EN 13501-1

PU
flame behaviour B2 according to DIN 4102-1

insulation thickness: 60 mm^{1/2} / 100 mm

subfloor: 0.6 mm thick, galvanised steel sheets (subject to differing steel finish)

floor:

floor plates: **chipboard**¹ thickness 22 mm
E1 in accordance to EN 312:2003,
fire behaviour D-s2, d0 respectively D_{fl}-s1 in accordance to EN13 501-1

plywood board thickness 21 mm

E1 in accordance to EN 717-2 and
fire behaviour D-s2, d0 respectively D_{fi}-s1 in accordance to EN 13501-1

cement-bound chipboard² thickness 20 mm
E1 in accordance to EN 717-1
fire behaviour A2-s1, d0 in accordance to EN13501-1

floor cover: **vinyl floor cover**¹ thickness 1.5 mm
fire behaviour B_{fi}-s1 in accordance to EN13 501-1
European classification: EN 685; stress class 23 - 31
welded seams

vinyl floor cover thickness 2.0 mm
fire behaviour B_{fi}-s1 in accordance to EN13 501-1
European classification: EN 685; stress class 34 - 43
welded seams

pvc knob floor² thickness 1.1 + 0.2 mm
fire behaviour B_{fi}-s1 in accordance to EN13 501-1
European classification: EN 685; stress class 22
welded, in the sanitary parts or pulled up on request
aluminium checker plate thickness 3 + 1 mm

2.2 Roof

frame construction: - made of cold rolled, welded steel profiles, thickness 3 mm
- 4 corner casts, welded
- roof cross members made of wood

cover: galvanised steel plate with double rabbet, thickness 0.6 mm

insulation type: **MW**^{1/2}
fire behaviour A1 (non-flammable) in accordance to EN 13501-1

PU
flame behaviour B2 according to DIN 4102-1

insulation thickness: 100 mm^{1/2} / 140 mm

ceiling sheeting: **coated chipboard**¹
10 mm thick, white,
E1 in accordance to EN 312,
flame behaviour D-s2, d0 according to EN 13501-1

plasterboard with coated steel plate²
10mm thick, colour: white (similar RAL 9010)
flame behaviour A2-s1,d0 according to EN 13501-1

CEE connectors: externaly sunk into short sided container frame

2.3 Corner posts

- cold rolled steel profiles, thickness 4mm
- steel quality S275JR+AR (St 44)
- screwed to the roof and floor frame

2.4 Wall panels

wall thickness 60² / 70¹ / 110 mm (depending on insulation type)

- available items:
- full
 - door
 - window
 - air conditioning
 - sanitary window
 - half
 - double (only with windows or doors)
 - fixed glazing

external cladding: corrugated, galvanised and coated steel sheet, thickness 0.6 mm

insulation type: **MW**¹
flame behaviour according to EN 13501-1, A1 – non-flammable

PU²
flame behaviour B-s3, d0 according to EN 13501-1

insulation thickness: 60 mm^{1/2} / 100 mm / 110 mm

internal cladding: **coated chipboard**¹
thickness 10 mm, light oak¹ / white.
E1 in accordance to EN 312,
fire behaviour D-s2, d0 respectively Dfl-s1 in accordance to EN13 501-1

plasterboard with coated steel plate
thickness 10 mm, colour: white (similar RAL 9010)
flame behaviour A2-s1,d0 s1 in accordance to EN 13501-1

galvanised steel sheet²
thickness 0.5 mm, light oak / white²

Wall panels - design combinations:

insulation type	panel thickness	external cladding	insulation thickness	internal cladding
MW	70 / 110	steel sheet	60 / 100	- double-sided coated chipboard - plasterboard with coated steel plate
PU	60 / 110		60 / 110	steel sheet

2.5 Partition walls

- available items:
- full panel
 - door panel
 - window panel
 - half panel

wooden construction¹ total thickness 60 mm

frame: wooden frame, thickness 40 mm

cladding on both sides: double-sided coated chipboard

Standard configuration: ¹ Office cabin, ² Sanitary cabin

10 mm thick, light oak / white
 E1 in accordance to EN 312,
 fire behaviour D-s2, d0 Dfl-s1 in accordance to EN13 501-1

steel version² total thickness 60 mm

frame: wooden frame with cardboard comb, thickness 60 mm

cladding on both sides: laminated steel plate, thickness 0.5 mm, colour: white (similar RAL 9010)

PU specification total thickness 45 mm (only CAH 2.591 mm)

cladding on both sides: galvanised steel sheet, thickness 0.5 mm, light oak

insulation: PU
 fire behaviour B-s3, d0 in accordance to EN 13501-1

2.6 Doors

- design according to DIN regulations
- right or left hand hinged
- inward or outward opening
- steel frame with triangular wrap-around sealing
- door blade with galvanised steel sheets on both sides

Dimensions:	nominal dimension	clear opening
	625 x 2,000 mm (only as internal and/or WC door)	561 x 1,940 mm
	875 x 2,000 mm ^{1/2}	811 x 1,940 mm
	1,000 x 2,000 mm	936 x 1,940 mm
	2,000 x 2,000 mm	1,936 x 1,940 mm
	inactive leaf with concealed frame joint	

- Optional:
- anti-panic push bar
 - door grille with security fittings (for modular dimensions 875 x 2,000 mm)
 - twin frame
 - door closer
 - insulated glazing: W x H =
 - 238 x 1,108 mm (ESG)
 - 550 x 1,108 mm (ESG)
 - 550 x 450 mm (ESG)

2.7 Window

design office window:

- pvc frame with insulated glazing and integrated pvc roller shutters; colour: white
- roller shutter housing with belt take-up reel and forced ventilations: housing height 145 mm, lamella colour light grey
- one hand tilt & turn mechanism

ATTENTION: The built-in insulation glass is only suitable for use at altitudes up to 1,100 m above sea level. Above 1,100 m sea level windows with a pressure compensating valve need to be used.

	<i>window options:</i>	<i>external dimension</i>
Standard window:	office window ¹	945 x 1,200 mm
	sanitary window ² (opaque windows)	652 x 714 mm
	optional: ESG glazing	
Optionale Fenster:	fixed glazing (ESG)	945 x 1,345 mm
	fixed glazing (ESG)	945 x 2,040 mm (CAH 2,591 mm)
	fixed glazing (ESG)	945 x 2,250 mm (CAH 2,800 mm und 2,960 mm)
	fixed glazing (ESG)	1,970 x 1,345 mm
	fixed glazing with sliding part (ESG)	945 x 1,200 mm
	double sliding window	1,970 x 1,200 mm
	double window	1,970 x 1,200 mm
	windows with pass-through / speak-through	945 x 1,200 mm

window parapet:

(vertical distance between floor level and the upper edge of the lower profile of the window frame)

office window (CAH 2,591 mm)	870 mm ¹
office window (CAH 2,800 mm, 2,960 mm)	1,030 mm
Optional CAH 2,800 and 2,960 mm)	870 mm
sanitary window	1,525 mm

- Optional:
- Window grille (office and sanitary windows)
 - ventilation slider inside roller shutter housing
 - security glazing with office windows
 - foamed aluminium roller shutters with chain tension cords and roller shutter rails

3 Electrical installation

Specification: concealed cabling

IP20¹/IP44²

plug insert according to country standards (VDE, CH, GB, F, CZ/SK, DK)

country specific design / variations possible

3.1 Technical data

	basis VDE (= OEVE, SKAN, CZ/SK)	F	GB	CH, DK
connection:	recessed CEE external plug and socket connections			
voltage:	230V/3 poles/ 32 A ^{1/2}			
	400V/5 poles/ 32 A ^{1/2}			
frequency:	50 Hz			
protection:	residual current operated device 40 A/0,03 A ^{1/2} , 4 poles (400 V)			
	residual current operated device 63 A/0,03 A, 2 poles (230 V) ^{1/2}			
distribution board:	distribution box, surface mounted type, single/twin row ¹ distribution box, surface mounted type, single/twin row wet room ²			
cable:	(N) YM-J / H05 VV-F	RO2V	(N) YM-J / H05 VV-F	
electrical circuits:	light	circuit breaker 10 A, 2 poles (3x1,5 mm ²) ^{1/2}		
	heating	circuit breaker 13 A, 2 poles (3x1,5 mm ²) ^{1/2}		
	socket	circuit breaker 13 A 2 poles (3x2,5 mm ²) ^{1/2}		circuit breaker 10A 2 poles (3x1,5 mm ²)
socket:	2 earthed twin wall sockets ¹ (office cabin 20') 3 single sockets ² (sanitary cabin 20')			
lighting:	light switch ^{1/2}			
	2 twin batten fluorescent light tubes with plastic covering 2 x 36 W ¹ (office cabin 20')			
	2 single light with trough and fluorescent tube 1 x 36 W ² (sanitary cabin 20')			

- Optional:
- Category 2 light fittings 2 x 36 W
 - light with bulb 25 W
 - spur

- according to following CENELEC regulations:
- HD 60364-1:2008
 - HD 60364-4-441:2007
 - HD 60364-7-717:2004
 - HD 60364-7-701:2007
 - HD 384.4.482 S1:1997
 - HD 384.7.711 S1:2003

earthing: universally usable grounding terminal:

On both short sides in the floor frame of each corner a drill hole with a diameter of 9.4 mm is prepared for the fixture of the grounding terminal.

- The fitting of the grounding terminal is undertaken with a screw M10 with a self-cutting screw thread. The positioning of the screw is carried out in the factory on a suitable spot of the cabin.

- A grounding terminal and a four-wire connector are delivered with the container and need to be fitted by the customer on site.

- The protective earthing installation on site must be carried out by the buyer/hirer.

- Wiring:
- Fixed cabling depending on the panel configuration and the user ^{1/2}
 - Flexible cable system with plug contact and cables in full length ^{1/2}

Safety advice: The cabins can be linked electrically at the external CEE plugs and sockets. For the decision how many units to connect electrically the expected constant current in the link circuits has to be considered. The commissioning has to be carried out by an approved electrician.

The manual for the assembly, start up, utilisation and maintenance of the electrical installations is delivered in the fuse box and needs to be followed!

Before connecting the cabin to the supplying low voltage grid all appliances (consumer loads) need to be switched off and earthing needs to be ensured (earthing feed cable and earthing connecting lines between the cabins need to be checked on potential equity and low Ohm level).

Attention: The supply- and connection cables are made for an operating voltage of max. 32 Ampere. These aren't secured with a overcurrent protection device. The connection of the cabins to the external electrical power supply only may be undertaken by an authorised specialist company.

Before using the cabin (modular building) for the first time the effectiveness of the protection measures for the fault protection need to be checked by an authorised specialist company.

- Cleaning with a high-pressure cleaner is FORBIDDEN.
The electrical equipment of the cabin may not be cleaned by a direct water jet under any circumstances.
- If the containers are delivered into areas with increased lightning activity further measurements have to be taken under account to prevent overvoltage depending on the country specific rules.
- In case machines or appliances with high starting current peaks are used (according to the manual of the respective appliances) adequate RCD/MCB must be used.
- The electric fittings of the cabins are designed for minimal vibration exposure. If the exposure is higher measurements need to be taken depending on country specific rules.
- The cabins are designed for areas with little seismic activity. If the cabins are used in areas with higher seismic activity, the country's national regulations are valid and the equipment needs to be adjusted accordingly
- The choice of the external linking cables of the cabins has to suit the country's national technical regulations.
- The cabins have to be secured against thermal overload with a type gL fuse or gG with max. IN = 32A.

3.2 Heating and air conditioning

Individual heating through frost heaters, thermostatically controlled electric convectors and/or fan heaters with safety switch for overheating.

Mechanical ventilation options with electrical ventilators or on your request also available with window air conditioning units.

Regular ventilation of the rooms must be provided. A relative humidity of 60 % should not be exceeded in order to avoid condensation!

		output:
Description: (amount depends on container type)	ventilator ²	170 m ³ /h
	hygrostatic ventilator	170 m ³ /h
	gas heating	2 kW
	air conditioning	2,6 kW
	convector heater ¹	2 kW
	fan heater ²	2 kW
	frost heater	0,5 kW

4 Miscellaneous

4.1 Transport height

The office cabins can also be delivered flatpacked.
Standard packet height 648 mm. Four cabins stacked on top of each other have the same external dimensions as a fully assembled cabin.

TP package height (only for office cabins and depending on equipment):

- 864 mm - standard with CAH 2,800 mm and 2,960 mm	6 pieces / truck
- 648 mm - standard with CAH 2,591	8 pieces / truck
- 515 mm - depending on layout	10 pieces / truck

4.2 Construction / Assembly / Statics / Servicing

General information:

Each individual cabin must be placed on foundations provided on site (e.g. wood, concrete) with at least 4 points of support for 10' cabins, 6 points of support for 16' or 20' cabins (attachment 6.5) and 8 points of support for 30' cabins (attachment 6.6). The dimensions of the foundation has to be adapted to local circumstances, norms and frost line, under consideration of the local soil condition and the maximum possible loads. The levelness of the foundation is a precondition for a smooth assembly and the failure-free standing of the entire construction.

During set up or placement of the cabin (constructions), maximum permitted loads and regional conditions (e.g. snow loads) must be taken into account.

Possible combinations of several cabins:

Individual cabins can be selectively configured next to, behind, or on top of each other, while bearing in mind the structural indications and the max. permitted loads. For one-level (ground level) constructions, the cabins may be placed arbitrarily and without restriction regarding quantity. For two- and three-storey buildings, the combination possibilities presented in appendix 6.1/ 6.2 (10', 16' and 20' cabins) or in 6.3/ 6.4 (24' and 30' cabins) must be followed.

In case the cabins are linked in other combinations than presented in appendix 6.1/ 6.2 (10', 16' and 20' cabin) or appendix 6.3 / 6.4 (24' and 30' cabin), we can give no statement about the max. permitted wind load. We categorically recommend keeping a distance from such a practice or to carry out additional anchorings (boltings, supports etc.) with the approval of authorised experts.

The containers must be stacked exactly on top of each other. The special CTX-stacking cones must be used.

The container roof is not suitable for storage of goods and materials.

The CONTAINEX assembly manuals need to be followed. These can be obtained as a registered trading partner on www.containex.co.uk or can be forwarded on request.

The service notes of Containex need to be respected.

Sanitary fittings:

After connecting with the water supply the entire water circulation should be checked once more on water tightness (possible loosening during transport).

CONTAINEX denies any warranty for damages, which may result from placement contrary to the principles. Liability for consequential damages is excluded on principle.

4.3 Handling

- with fork lift
- with crane: angle between lifting rope and horizontal line must be at least 60 °

Due to construction and design, handling with spreader is not allowed.
(Appendix 6.7 / 6.8)!

4.4 Certification

Germanischer Lloyd 'type test' (except 24' and 30' office cabin)

4.5 Paint

Paint system with high weather and aging durability, suitable for city and industry atmosphere.

Wall panels: 25 µm coating thickness

frame: 15-40 µm grounding
40-60 µm top coat

The painting of above mentioned parts is carried out with different types of production. These achieve shades similar to RAL. We do not accept liability for colour variations in comparison with the RAL tones.

5 Equipment options for sanitary cabins and fixtures in office cabins

- handicapped accessible fixtures
- floor drainage channel / gully
- floor cover pulled up
- boiler: 80L / 150L / 300 L
- pressure-reducing valve
- shower cubicle with folding door
- shower cubicle with curtain
- single lever tap for hand wash basin, mini kitchen, shower
- wet room electrics (FR - electric)
- GFK hand wash trough with 2 individual basins l = 1,200 mm
- GFK hand wash trough with 4 individual basins l = 2,400 mm
- electrical hand dryer
- ceramic hand wash basin
- WC
- coat hook
- water installation (water supply and drain)
- metal mirror
- mini kitchen
- paper towel dispenser
- sanitary connections sunk in panel
- intermediate panel
- soap dispenser
- stop & go fixtures for hand wash basins and shower
- telephone duct
- urinal
- canopy roof large / small
- additional water supply
- WC cabin
- undersink water heater 5L

- Fire rated components

roof section with fire retardancy class EI60
according to EN 13501-1

wall elements with fire retardancy class EI90
according to EN 13501-1

5.1 WATER INSTALLATION

supply supply using ½", ¾" or 1" pipe, sideways through cabin wall

internal: PVC pipework

operating pressure max. permitted operating / connection pressure - 4 bar
warm water preparation: by using electric boilers, depending on the cabin type (80, 150 or 300² liters)

ATTENTION:

The boilers with 80/150/300 l capacity are suitable for a max. operating pressure of 6 bar. A higher water pressure is reduced with an appropriate pressure reducing valve!

discharge: The waste water is collected via PVC pipes, DN 50, DN 100 or and DN 125 (external diameter Ø 50, 110 and 125 mm) and discharged sideways through the cabin wall.

The discharge of the waste water into an authorised sewage network has to be undertaken by the buyer/hirer in compliance with the official regulations for waste and faecal water.

Further technical information upon request.

Regulatory and legal requirements for the storage, placement and usage of the containers must be considered by the buyer/hirer.

The suitability of the container (modular building) and of the possibly also supplied options (e.g. stairs, air conditionings etc.) needs to be examined by the purchaser / hirer for the intended purpose.

Subject to technical alterations.

6 Appendix

6.1 Arrangement options for 10', 16' and 20', max. external height 2.8 m

Number of cabins (SxLxH): Short side (S) x Long side (L) x Height (H)

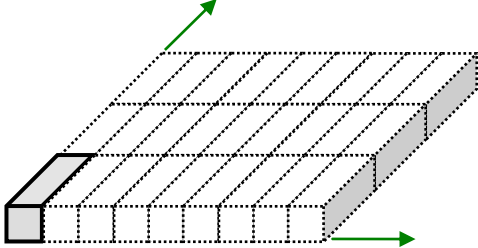
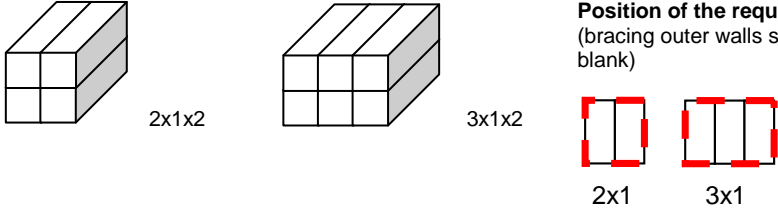
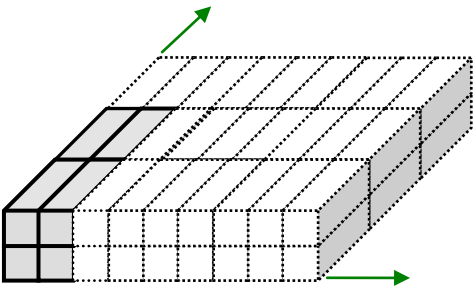
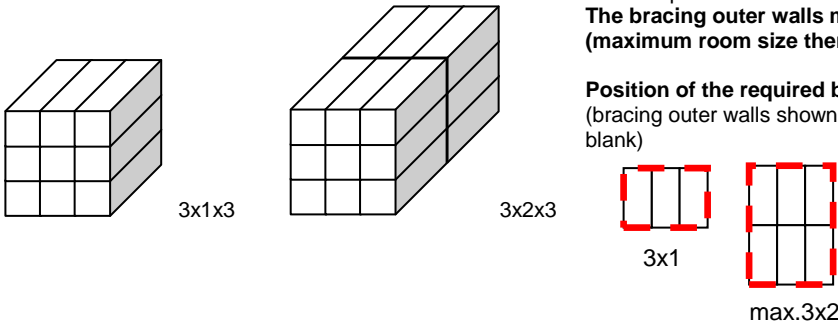
<p style="writing-mode: vertical-rl; transform: rotate(180deg);">1-storey</p>	 <p>The cabins can be linked at will or positioned individually, without restriction to the size of rooms.</p>
<p style="writing-mode: vertical-rl; transform: rotate(180deg);">2-storey</p>	<p>Single line modular buildings (quantity of long sides = 1)</p>  <p>The illustrated two-storey modular buildings can be linked at will or positioned individually. The bracing outer walls must not be removed (maximum room size therefore 3x1 cabins).</p> <p>Position of the required bracing outer walls (bracing outer walls shown with dashed lines; inside rooms blank)</p>
<p style="writing-mode: vertical-rl; transform: rotate(180deg);">2-storey</p>	<p>Multiple rows modular buildings (quantity of long sides ≥ 2)</p>  <p>From a minimum size of 2x2x2 cabins an extension of the building in all directions is possible, without restriction to the size of rooms.</p>
<p style="writing-mode: vertical-rl; transform: rotate(180deg);">3-storey</p>	 <p>The illustrated three-storey modular buildings can be linked at will or positioned individually. The bracing outer walls must not be removed (maximum room size therefore 3x2 cabins).</p> <p>Position of the required bracing outer walls (bracing outer walls shown with dashed lines; inside rooms blank)</p>

6.2 Arrangement options for 10', 16' and 20', max. external height 2,96 m

Number of cabins (SxLxH); Short side (S) x Long side (L) x Height (H)

1 - storey		<p>The cabins can be linked at will or positioned individually, without restriction to the size of rooms.</p>
2 - storey	<p>Single and double row modular buildings (amount of long sides ≤ 2)</p>	<p>The illustrated two-storey modular buildings can be linked at will or positioned individually. The bracing outer walls must not be removed (maximum room size therefore 3x2 cabins). Position of the required bracing outer walls (bracing outer walls shown with dashed lines; inside rooms blank)</p>
2 - storey	<p>Multiple rows modular buildings (amount of long sides ≥ 3)</p>	<p>From a minimum size of 3x3x2 cabins an extension of the building in all directions is possible, without restriction to the size of rooms.</p>
	3 - storey	

6.3 Arrangement options for 24' and 30', max. external height 2,8 m

Number of cabins (SxLxH): Short side (S) x Long side (L) x Height (H)

1 - storey		<p>The cabins can be linked at will or positioned individually, without restriction to the size of rooms.</p>
2 - storey	<p>Single line modular buildings (quantity of long sides = 1)</p>	<p>The illustrated two-storey modular buildings can be linked at will or positioned individually. The bracing outer walls must not be removed (maximum room size therefore 3x1 cabins).</p> <p>Position of the required bracing outer walls (bracing outer walls shown with dashed lines; inside rooms blank)</p> <div style="display: flex; justify-content: space-around; align-items: center;"> <div style="text-align: center;"> 2x1x2 </div> <div style="text-align: center;"> 3x1x2 </div> </div> <div style="display: flex; justify-content: space-around; align-items: center; margin-top: 10px;"> <div style="text-align: center;"> 2x1 </div> <div style="text-align: center;"> 3x1 </div> </div>
	<p>Multiple rows modular buildings (quantity of long sides ≥ 2)</p>	<div style="display: flex; justify-content: space-between;"> <div style="width: 45%;"> </div> <div style="width: 45%;"> <p>From a minimum size of 2x2x2 cabins an extension of the building in all directions is possible, without restriction to the size of rooms.</p> </div> </div> <div style="display: flex; justify-content: space-between; margin-top: 20px;"> <div style="width: 45%;"> </div> <div style="width: 45%;"> <p>From a minimum size of 3x3x2 cabins an extension of the building in all directions is possible, without restriction to the size of rooms.</p> </div> </div>
3 - storey	<div style="display: flex; justify-content: space-around; align-items: center;"> <div style="text-align: center;"> 3x1x3 </div> <div style="text-align: center;"> 3x2x3 </div> </div>	<p>The illustrated three-storey modular buildings can be linked at will or positioned individually. The bracing outer walls must not be removed (maximum room size therefore 3x2 cabins).</p> <p>Position of the required bracing outer walls (bracing outer walls shown with dashed lines; inside rooms blank)</p> <div style="display: flex; justify-content: space-around; align-items: center; margin-top: 10px;"> <div style="text-align: center;"> 3x1 </div> <div style="text-align: center;"> max.3x2 </div> </div>

6.4 Arrangement options for 24' and 30', max. external height 2,96 m

Number of cabins (SxLxH); Short side (S) x Long side (L) x Height (H)

1 - storey		<p>The cabins can be linked at will or positioned individually, without restriction to the size of rooms.</p>
2 - storey	<p>Single line modular buildings (quantity of long sides = 1)</p> <p>2x1x2 3x1x2</p>	<p>The illustrated two-storey modular buildings can be linked at will or positioned individually. The bracing outer walls must not be removed (maximum room size therefore 3x1 cabins).</p> <p>Position of the required bracing outer walls (bracing outer walls shown with dashed lines; inside rooms blank)</p> <p>2x1 3x1</p>
	<p>Double row modular buildings (amount of long sides = 2)</p>	<p>From a minimum size of 2x2x2 cabins an extension of the building in all directions is possible, without restriction to the size of rooms.</p>
	<p>The double row modular buildings shown can be connected in any order on the short sides to multi row modular buildings. The stiffening external walls may not be removed (max. room space due to this is Nx2 cabins).</p> <p>Position of the required bracing outer walls (bracing outer walls shown with dashed lines; inside rooms blank)</p>	
3 - storey	<p>3x1x3 3x2x3</p>	<p>The illustrated three-storey modular buildings can be linked at will or positioned individually. The bracing outer walls must not be removed (maximum room size therefore 3x2 cabins).</p> <p>Position of the required bracing outer walls (bracing outer walls shown with dashed lines; inside rooms blank)</p> <p>3x1 max.3x2</p>

Abb.1

6.5 Standard foundation plan for 10', 16' und 20' cabin

Each individual cabin must be placed on foundations provided on site with at least 4 points of support for 10' cabins, 6 points of support for 16' or 20' cabins. The smallest foundation size is 20 x 20 cm, but dimensions of the foundation have to be adapted to local circumstances, norms and frost line, under consideration of the local soil condition and the maximum possible loads. These measures have to be undertaken by the buyer/hirer.

Cabin length (l); Cabin width (b)

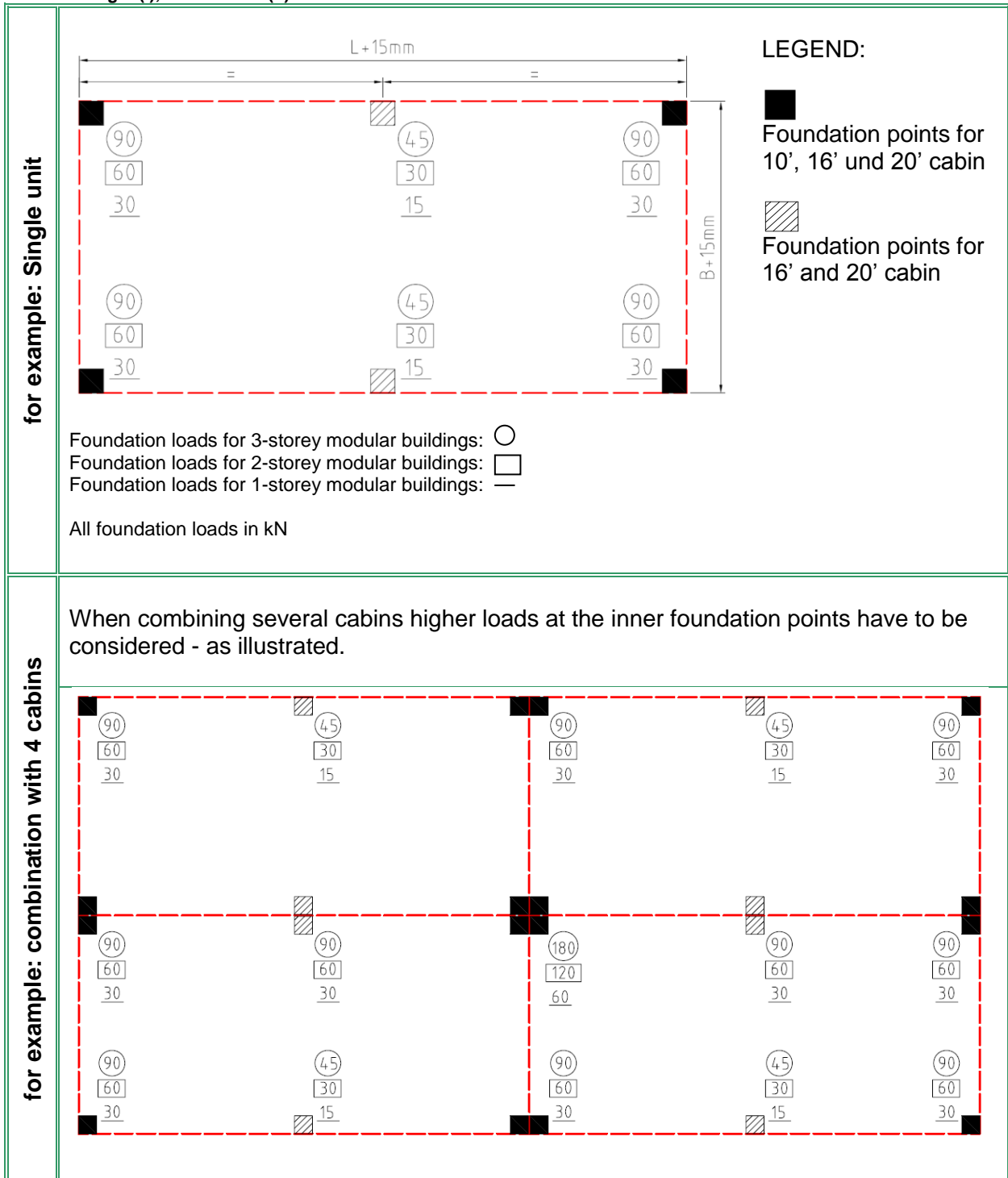

6.6 Standard foundation plan for 24' and 30' cabin

Each individual cabin must be placed on foundations provided on site with at least 8 points of support. The smallest foundation size is 20 x 20 cm, but dimensions of the foundation have to be adapted to local circumstances, norms and frost line, under consideration of the local soil condition and the maximum possible loads. These measures have to be undertaken by the buyer/hirer.

Cabin length (l); Cabin width (b)

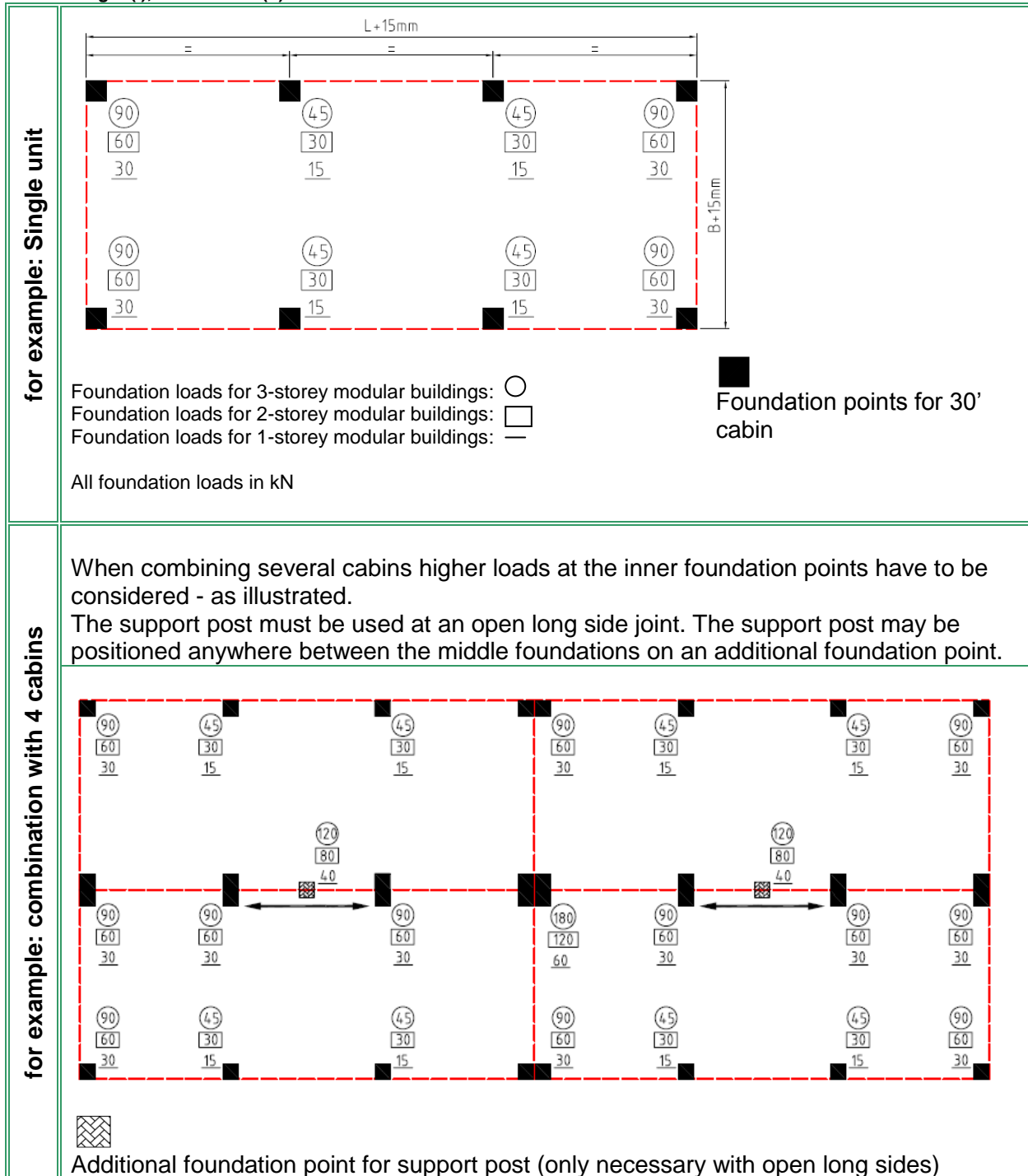

6.7 Handling instructions for 10', 16' and 20' Transpack cabins

1. The packets must only be lifted with a forklift or crane. The ropes need to be fastened to the upper cabin corners. The angle between the rope/chain and the horizontal line must be a minimum of 60° (picture 1).

Due to the construction and design, handling with a spreader is not possible!

2. Only single packets of the Transpack cabins are allowed to be lifted.
3. 4 pieces of stacking cones (in the corner casts) and 2 pieces of clamping wedges (1 piece on each of the longside roof sections) must be put between the individual packets (picture 2).
4. Do not place any extra weight on the top packet!
5. You must only stack max. 5 packets on top of each other.

Possible packet heights:

- 864 mm - Standard with external cabin height 2,800 mm and 2,960 mm
- 648 mm - Standard with external cabin height 2,591 mm
- 515 mm - depending on layout

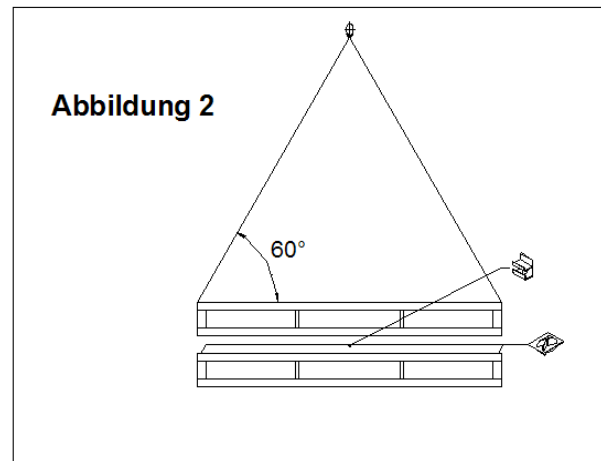
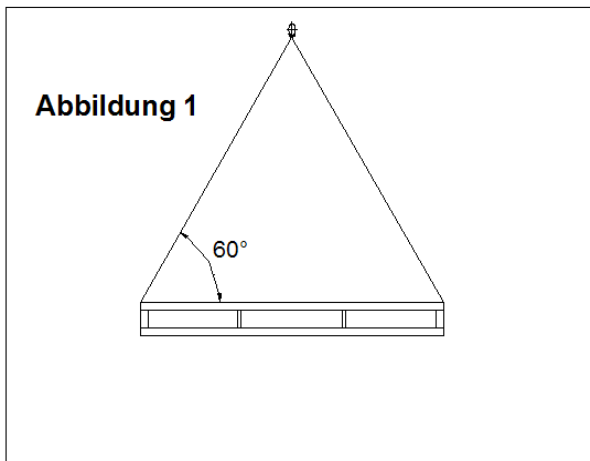

6.8 Handling instruction for 30' Transpack cabins

1. The packets must only be lifted with a forklift or crane. The ropes/chains must be fastened on the crane hooks screwed to the top frame. The angle between the rope/chain and the horizontal line must be a minimum of 60° (picture 1).

Due to the construction and design, handling with a spreader is not possible.

2. Only single packets of the Transpack cabins are allowed to be lifted.
6. 4 pieces of stacking cones (in the corner casts) and 4 pieces of clamping wedges (2 piece on each of the longside roof sections) must be put between the individual packets (picture 2).
7. Do not place any extra weight on the top packet!
8. You must only stack max. 5 packets on top of each other.

Possible packet heights:

- 864 mm - Standard with external cabin height 2,800 mm and 2,960 mm
- 648 mm - Standard with external cabin height 2,591 mm
- 515 mm - depending on layout

